

# Cement Resistors, Ceramic Resistors, Heater Resistors

TYPE: SQP & SQM    Series  
TYPE: SQZ & SQS    Series  
TYPE: SQH & SQHG   Series  
TYPE: SQF & SRBB   Series  
TYPE: SQFR          series

Power Rating: 3W-100W  
Resistance Value: 0.01  $\Omega$ -100K  $\Omega$   
Resistance Tolerance:  $\pm 0.1\%$ ,  $\pm 0.5\%$ ,  $\pm 1\%$ ,  $\pm 5\%$ ,  $\pm 10\%$

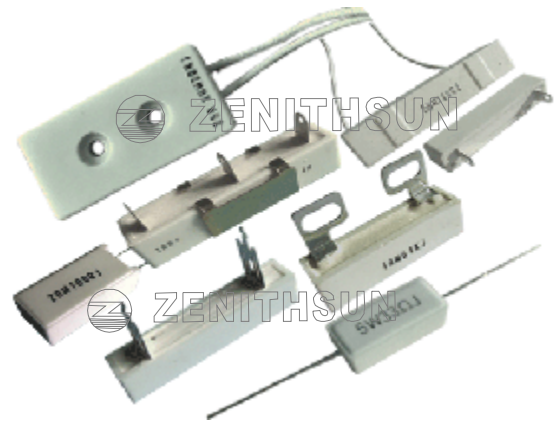

## ● Construction:

- 1.cement resistors are made by winding resistance wires around non-alkaline ceramic core, which is adde with a layer of heat and humidity resistant and non-corrosive protective material.
- 2.The wire wound resistor is then placed in a square ceramic package sealed with special nonflammable heat-resistant cement.
- 3.For high resistance value,wires are replaced by metal oxide films

## ● Features:

- 1.Small size,resistant to vibration,humidity and heat,good dissipation,low noise and no annual shift in resistance value,low price
2. ZENITHSUN is equipped to design and produce custom components to meet many design and reliability demands. Contact us with your specific needs.
- 3.Delivery:5-7days
4. Conforms to the ROHS standard and the LEAD-FREE non-lead standard.

## ● Applications:

Complete insulation suitable for printed circuit boards,Power supplies ,Voltage dividers , Motor controllers ,Automotive applications ,Power electronics circuits.

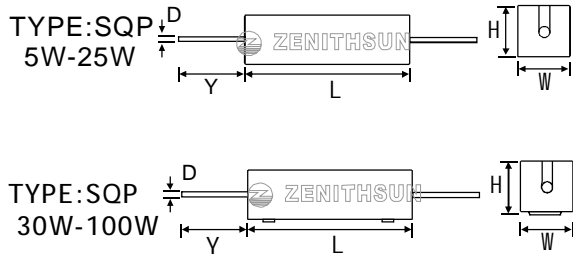
**● Dimensions**

POWER RATING	SR-SQP DIMENSIONS (mm)				
	L±1	W±1	H±1	Y±5	φ±0.05
5W	22	10	9	25	0.78
7W	35	10	9	25	0.78
10W	48	10	9	22	0.78
15W	48	12.5	12.5	25	0.78
20W	63.5	12.5	12.5	25	0.78
25W	60	14	14	25	0.78
30W	75	19	19	25	0.78
40W-60W	90	19	19	25	0.78
80W	108	19	19	25	0.78
100W	135	24	24	25	0.78

We can do the resistors following customer special requirement.

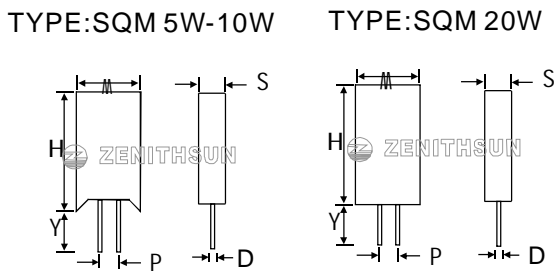

POWER RATING	SQM DIMENSIONS (mm)					
	W±1	S±1	H±1.5	Y±1	P±1	D±0.05
5W	13	10	25.5	5	5	0.78
7W	13	10	39	5	5	0.78
10W	13	10	51	10	5	0.78
	16	12	35	10	7	0.78
20W	20	10	40	10	8	0.78

We can do the resistors following customer special requirement.

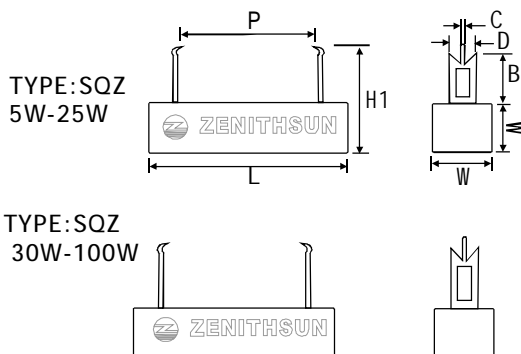

POWER RATING	SR-SQZ DIMENSIONS (mm)						
	L±1.5	W±1	P±1	B±0.5	C±0.1	D±0.1	H1±2
5W	28	10	15	10.5	1.5	5	25
7W	35	10	20	10.5	1.5	5	25
10W	48	10	34	10.5	1.5	5	25
15W	48	12.5	34	15	3	10	33
20W-25W	63	12.5	45	15	3	10	33
30W	76	19	58	12	3	10	35
40W	90	19	68	12	3	10	35
80W	108	19	88	12	3	10	35
100W	135	24	115	10	3	10	40

We can do the resistors following customer special requirement.

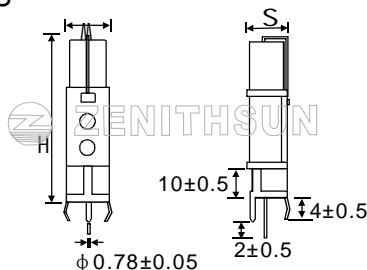
**TYPE:SQS**

POWER RATING	SR-SQS DIMENSIONS (mm)		
	W±1	S±1	H±2
7W	11.5	12.5	45
10W	11.5	12.5	60
20W	14	14.5	75

We can do the resistors following customer special requirement.

**● Dimensions**

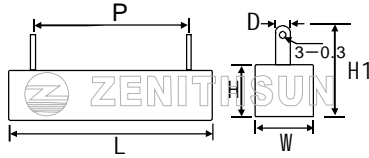
 TYPE:SQH  
 10W-25W

 TYPE:SQH  
 30W-100W

POWER RATING	SR-SQH DIMENSIONS (mm)					
	L±1.5	W±0.5	H±1	H1±2	P±2	D±0.5
10W	48	10	9.5	21	33	5
15W	48	12.5	12.5	21	33	5
20W	63.5	12.5	12.5	24	45	6
30W	76	19	19	31	55	8
40W	90	19	19	31	67	8
80W	108	19	19	31	90	8
100W	135	24	24	38	114	8

We can do the resistors following customer special requirement.

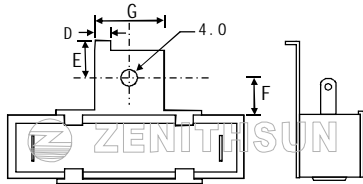
TYPE:SQHG



POWER RATING	SR-SQHG DIMENSIONS (mm)			
	D±0.3	E±1	F±1	G±1
10W	3	5.5	8	12
15W	3	5.5	8	12
20W	3	5.5	8	12
30W	3.5	8	10	18
40W	3.5	8	10	18
80W	3.5	8	10	18

We can do the resistors following customer special

TYPE:SQHG 100W

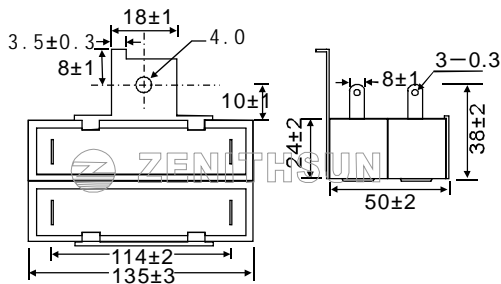

TYPE:SQHG 30W

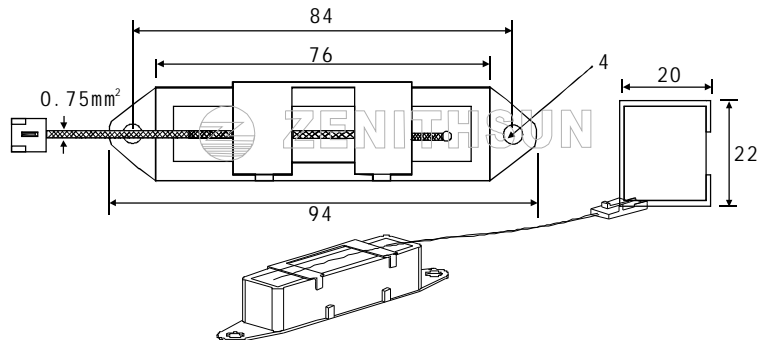

TYPE:SQFR Cement Resistor

SQFR Cement Resistor(heater resistors) are used in the water heater industry,custom special size is available.

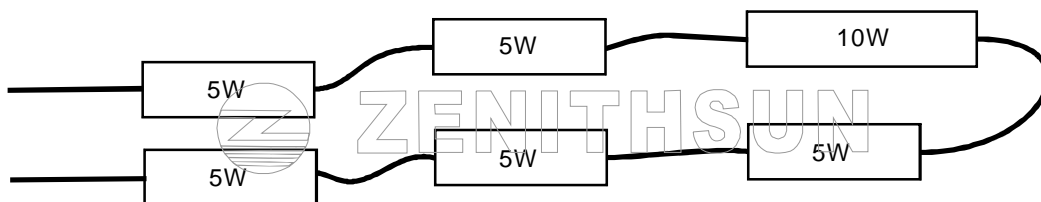

TYPE:SQF and SRBB Cement Resistor widely used in Industry、Controller.

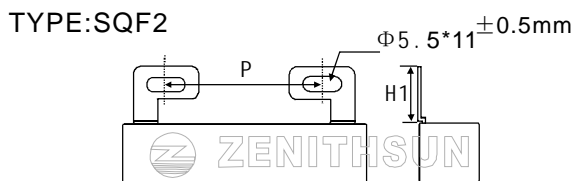
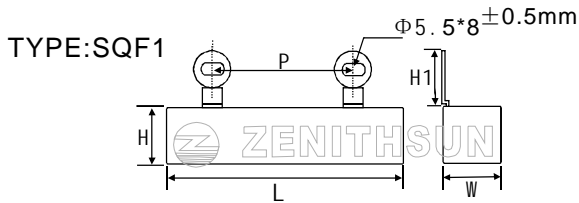

POWER RATING	SR-SQF DIMENSIONS (mm)				
	L±1.5	W±1	H±1	P±1	H1±1.5
10W	48	12.5	12.5	28	14
15W	48	12.5	12.5	28	14
20W	63.5	12.5	12.5	31.3	14
25W	63.5	12.5	12.5	31.3	14

We can do the resistors following customer special requirement.

TYPE:SRBB 60W and 80W

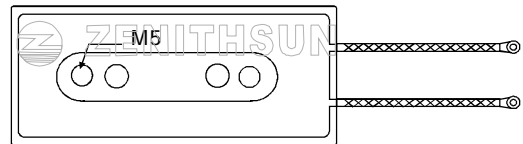
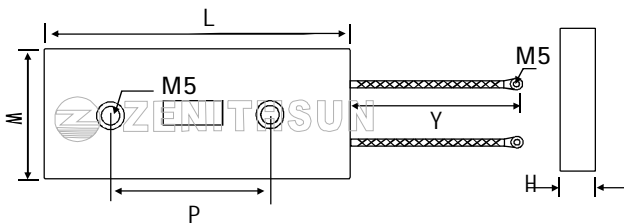

TYPE:SRBB 30W

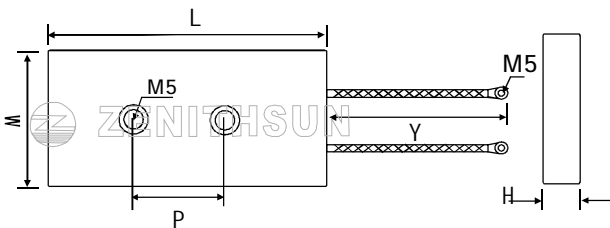

POWER RATING	SR-BB DIMENSIONS (mm)				
	L±3	W±1	H±1	P±1	Y±10
30W	62	30	10	20.5	300
60W	79	40	14	34.5	300
80W	89	44	14	34.5	300

We can do the resistors following customer special requirement.

## ● Surface Temperature

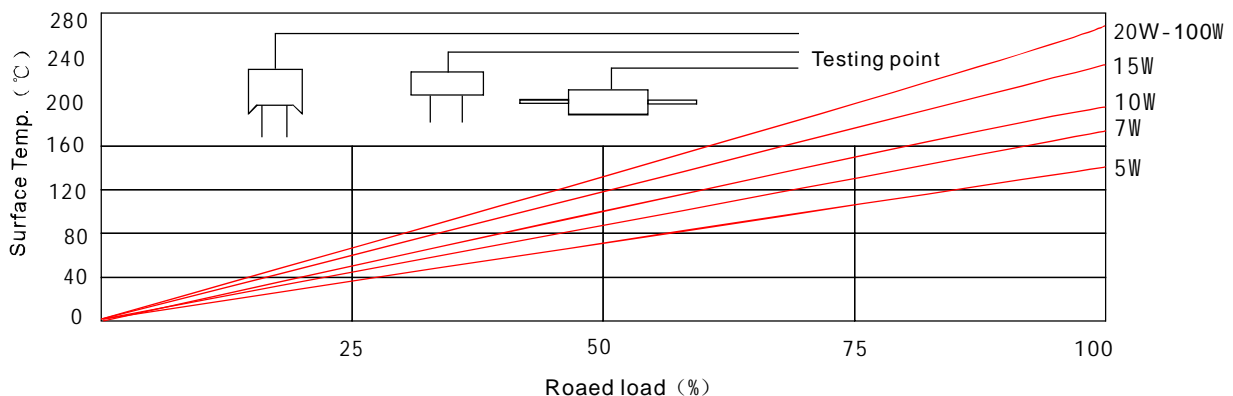

## ● Performance Specifications

Test item	Test condition	Specifications
Resistance tolerance	JIS-C-5202 5-1	Resistance Nominal Tolerance 1≤R 1>R ±5%(J) ±10%(K)
Temperature coefficient	-55℃ -155℃	±350PPM/℃ Max
Short-term overload	1000% rated power 5s	△R≤±(2%+0.1Ω)
Rated load	Rated wattage for 30 min	△R≤±(1%+0.1Ω)
Insulation resistance	DC 500V 60s	1000MΩ Min
Dielectric withstanding voltage	AC 1000V 60s	No change
Temp.Cycle	-30℃ ~85℃ for 5 cycles	△R≤±(1%+0.1Ω)
Load life	70℃ on-off cycle 1000H	△R≤±(5%R <sub>0</sub> +0.1Ω)
Moisture-proof Load life	40℃ ,90%-95% power rating 1.5H ON, 0.5OFF cycle 1000H	△R≤±(5%R <sub>0</sub> +0.1Ω)
Nonflammability	500%,1000%,1600% power rating 5min	No visable flame

## ● Derating

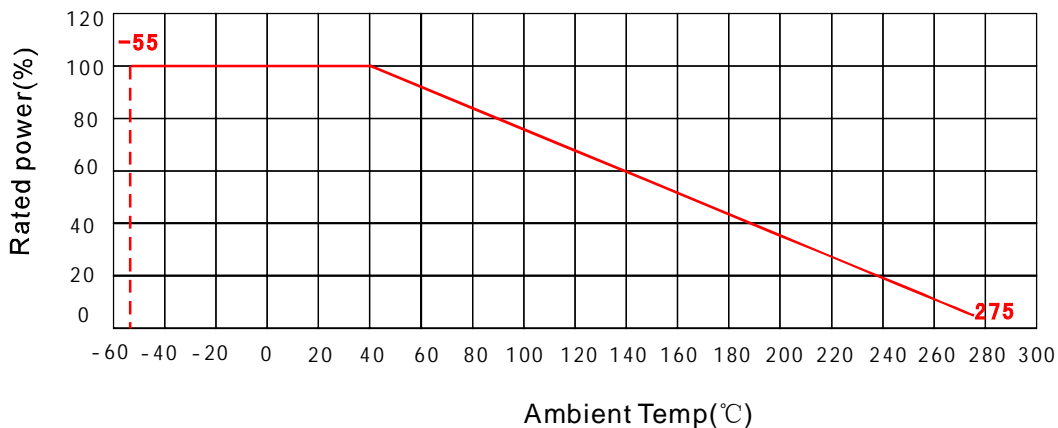

## ● How to order

SQP	5W	10R	J
Type	rated power (w)	resistance Value(Ω)	tolerance(%)
SQP	3W-100W	0.01Ω -100KΩ	B=±0.1% D=±0.5% F=±1% J=±5% K=±10%
SQM	5W-20W		
SQS	5W-20W		
SQZ	5W-100W		
SQH	10W-100W		
SQHG	10W-100W		
SQF	10W-25W		
SRBB	30W-100W		
SQFR	Custom special applications		